

Data Sheet



Article number: 20330334

Description: E+G Handwheel
GN 555-200-K20-A

Measures

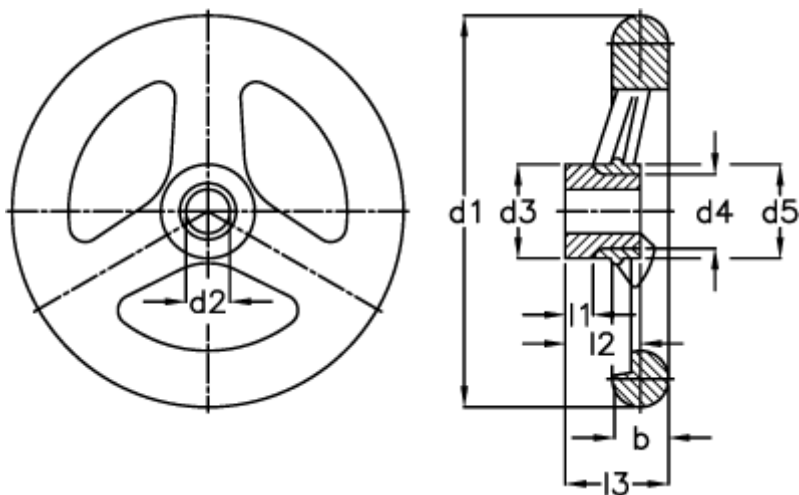

b	= 24	l2 -0.5	= 32
d1	= 200	l3	= 45
d2 H7	= 20	Number of spokes	= 3
d2 H7	= 18		
d3	= 40		
d4	= 31		
d5	= 45		
l1 -0.5	= 4		